

# HP-3 Indirect/Direct Installation Instructions

## Overview

### NOTES

- If the luminaire contains a sensor, refer to the Sensor Addendum.
- All power connections should be installed according to local/national codes by a Certified Electrician.
- This installation requires proper support as each luminaire is being installed.
- **DO NOT attempt to join luminaires together on the floor. Damage may result when lifted.**



HELPFUL  
VIDEOS



0-10V  
Dimming



Simple  
Plug-Together  
Wiring

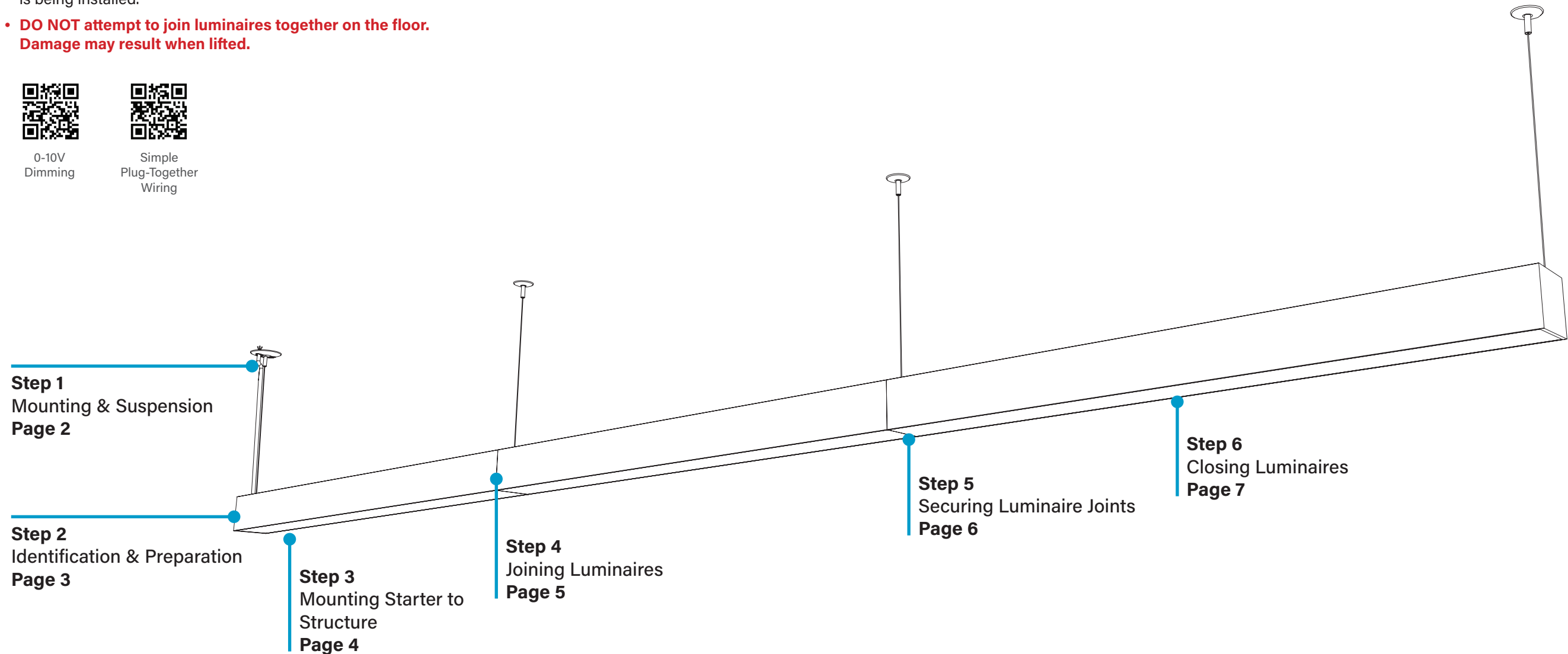

© 2025 FINELITE, INC. ALL RIGHTS RESERVED. Form - 98610-V1 EFFECTIVE DATE: 01/25

# HP-3 Indirect/Direct Installation Instructions

## Step 1 - Mounting & Suspension

### Mounting Options

#### Option 1 T-Bar Mounting - GridBox™ and Caddy Clips

- Install GridBox™ and electrical conduit at feed locations.
- Install caddy clips at mounting point locations.
- All caddy clips are to be secured to the structure, per local building codes.

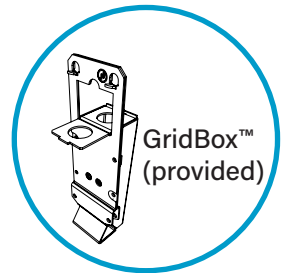

or

#### Option 2 Drywall (C4) or other hard surfaces\* - J-Box and Anchor Bolts

- Install J-Box and electrical conduit at feed locations.
- Install anchor bolts at mounting point locations.
- All anchor bolts are to be secured to the structure, per local building codes.

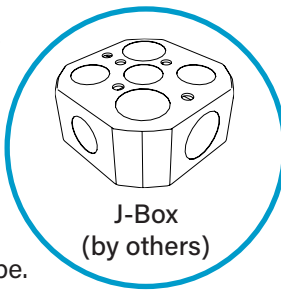

\* Other hard surfaces include: wood, sheet metal panels, steel beams, concrete or masonry. Use hardware appropriate for each surface material type.

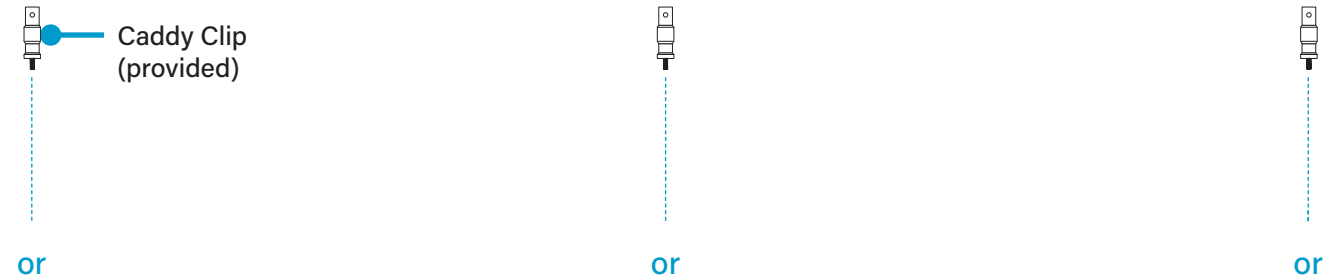

or

1/4" -20 Anchor Bolt  
(by others)

or

or

### Suspension Locations

X = Suspension Dimensions

Refer to Record Drawings and building plans to determine exact mounting, suspension points, and power feed locations.

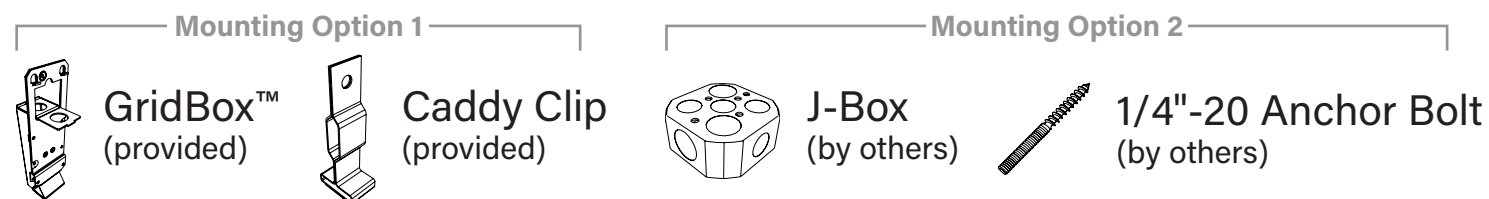
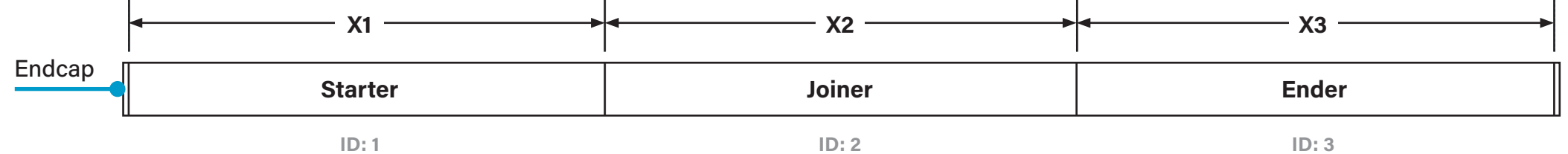

# HP-3 Indirect/Direct Installation Instructions

## Step 2 - Identification & Preparation

### A. Identify Luminaires

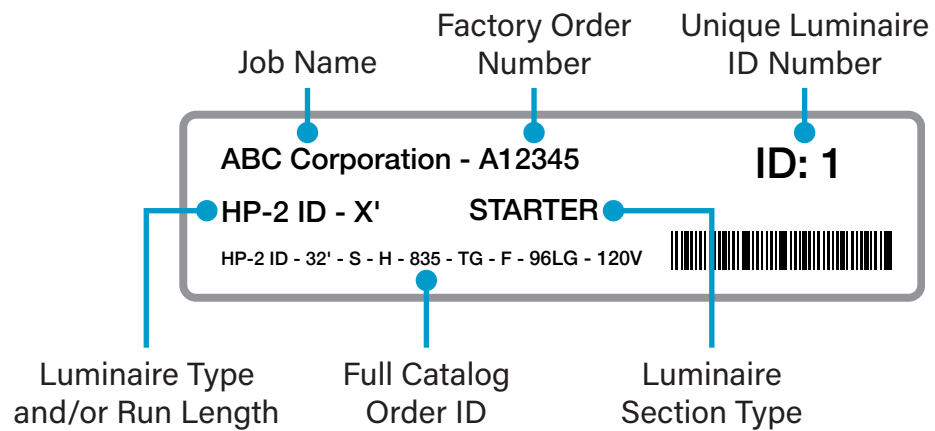
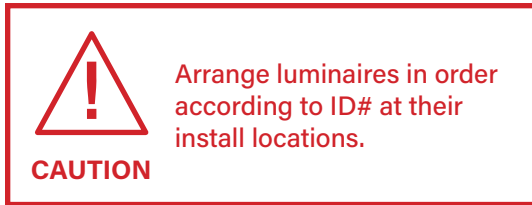

- Identify all luminaires by their ID label that can be found on the box, the diffuser, and inside the luminaire.
- NOTE: Exact location of labels in these areas may vary.
- Remove all luminaires from their box.
- Refer to Record Drawings that can be found in the hardware kit.

### B. Remove Downlight Diffusers

Remove Diffusers

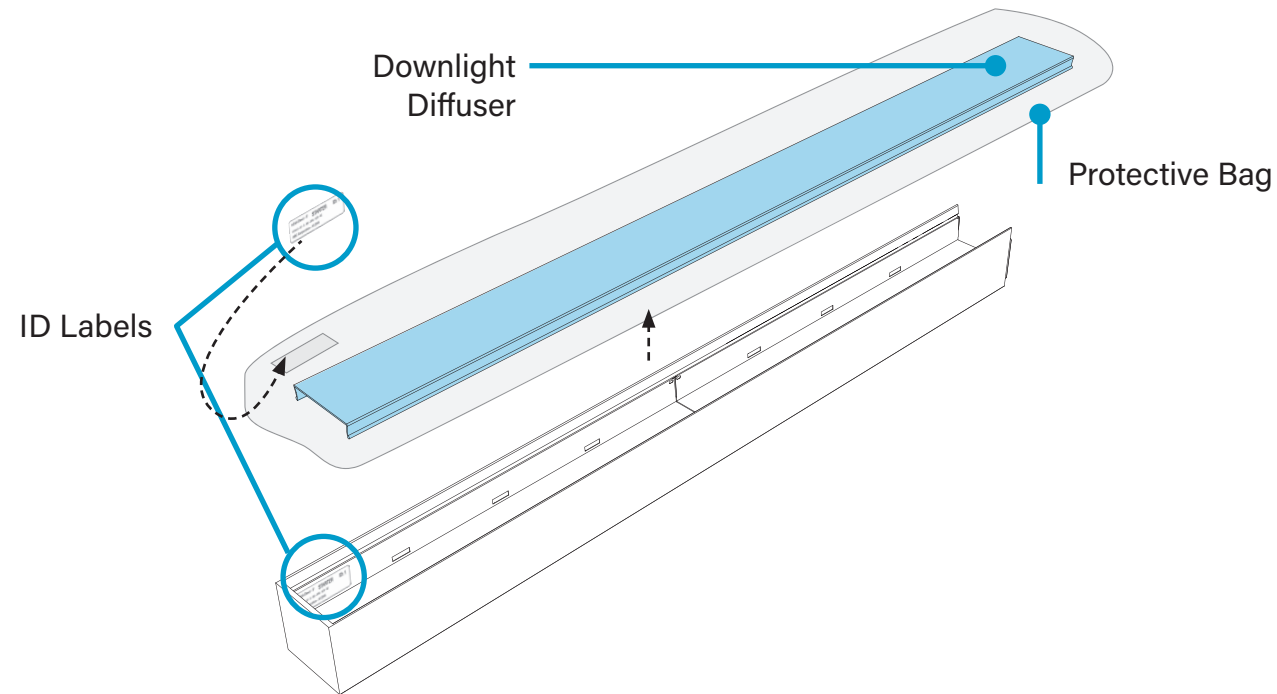

- Carefully remove all downlight diffusers, keeping them inside their protective bags.
- Set aside all downlight diffusers to prevent from getting dirty or damaged.
- Ensure downlight diffusers can be identified back to their corresponding luminaire.

### C. Remove Uplight Diffuser

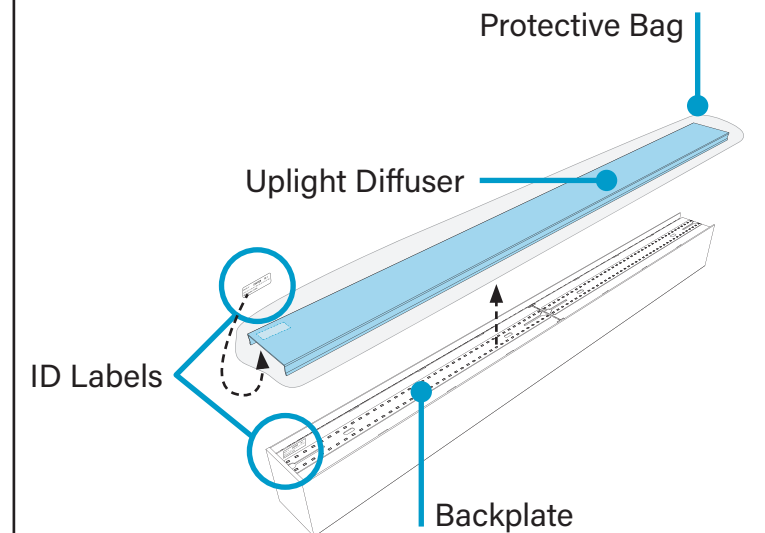

- Carefully remove all upright diffusers, keeping them inside their protective bag.
- Set aside all upright diffusers to prevent from getting dirty or damaged.
- Ensure upright diffusers can be identified back to their corresponding luminaire.

### Kitted Hardware

- Finelite has provided items listed here, with their Finelite part numbers. These items can be found in separate boxes shipped with the luminaire.
- Account for all parts and set aside until they are needed.
- All other hardware needed for this installation will be by others.

#### Mounting Option 1

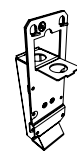

**GridBox™**  
Part# 89159

**Dual GridBox™**  
Part# 89199  
Mounting & Suspension  
p. 2, Step 1

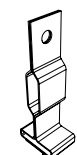

**Caddy Clip**  
C1 Ceiling - Part# 94001  
C2 Ceiling - Part# 94020  
C3 Ceiling - Part# 94029  
Mounting & Suspension  
p. 2, Step 1



**3-1/2" Canopy**  
Part# 89191

**3-1/2" Dual Feed Canopy**  
Part# 89192  
Mounting Starter to Structure  
p. 4, Step 3  
Joining Luminaires  
p. 5, Step 4

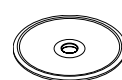

**3-1/2" T-Bar Support Canopy**  
Part# 89193  
Mounting Starter to Structure  
p. 4, Step 3  
Joining Luminaires  
p. 5, Step 4

#### Mounting Option 2



**5" Canopy**  
Part# 94085

**5" Dual Feed Canopy**  
Part# 94145  
Mounting Starter to Structure  
p. 4, Step 3  
Joining Luminaires  
p. 5, Step 4

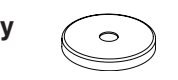

**2" Drywall Support Canopy**  
Part# 94017  
Mounting Starter to Structure  
p. 4, Step 3  
Joining Luminaires  
p. 5, Step 4



**Gripper**  
Part# 68129  
Mounting Starter to Structure  
p. 4, Step 3  
Joining Luminaires  
p. 5, Step 4



**Cable Bushing**  
Part# 94014

**Aircraft Cable**  
50" - Part# 94515-12 (Std.)  
100" - Part# 94515-14  
150" - Part# 94515-18  
Mounting Starter to Structure  
p. 4, Step 3  
Joining Luminaires  
p. 5, Step 4



**Safety Crimp**  
Part# 94514  
Closing Luminaires  
p. 4, Step 3



**Slip Ring w/ Set Screw**  
Part# 94015  
Mounting Starter to Structure  
p. 4, Step 3  
Joining Luminaires  
p. 5, Step 4

# HP-3 Indirect/Direct Installation Instructions

## Step 3 - Mounting Starter to Structure

### A. Mount Starter to Structure

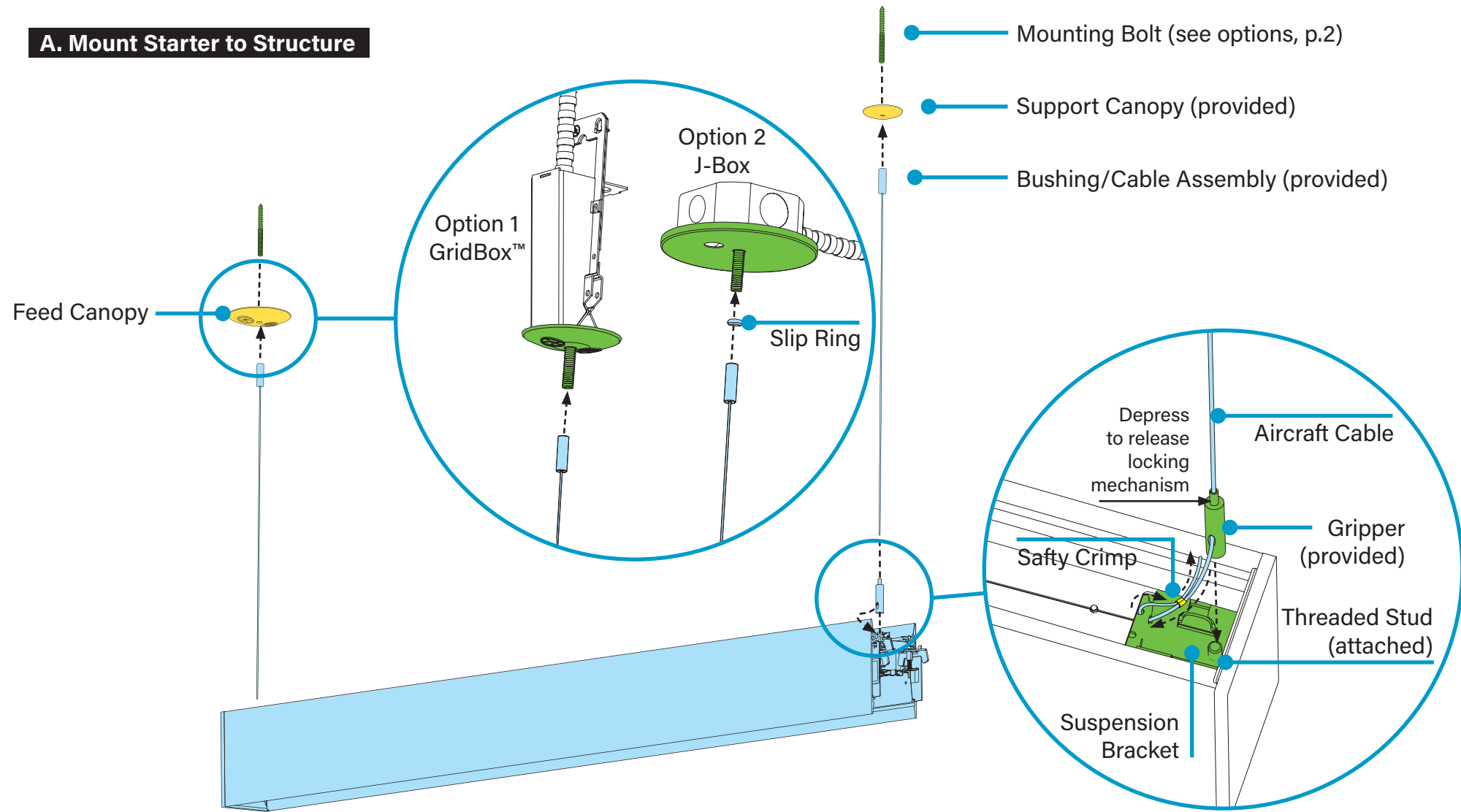

- Slide canopy appropriate for electrical type options onto mounting bolt (anchor bolt or caddy clip bolt).
- (Option 2 only) Thread the Slip Ring onto anchor bolts and secure it with a set screw at both mounting locations.
- Thread the bushing/cable assembly onto mounting bolts.
- Attach grippers onto threaded studs found on the end plates of the starter luminaire.
- While properly supporting the luminaire, maneuver the luminaire to the ceiling.

- Depress the top of the gripper to feed the Aircraft Cable through and lead into the feed hole.
- Loop cable through Safety Crimp and holes in Suspension Bracket, then back through Safety Crimp.
- Crimp, then cut the excess cable.

### B. Make Electrical Connections

WIRING LEGEND		
Black	Hot	Line Voltage
White	Neutral	Line Voltage
Green	Ground	
Pink	Dimming	0-10V DC
Purple	Dimming	0-10V DC

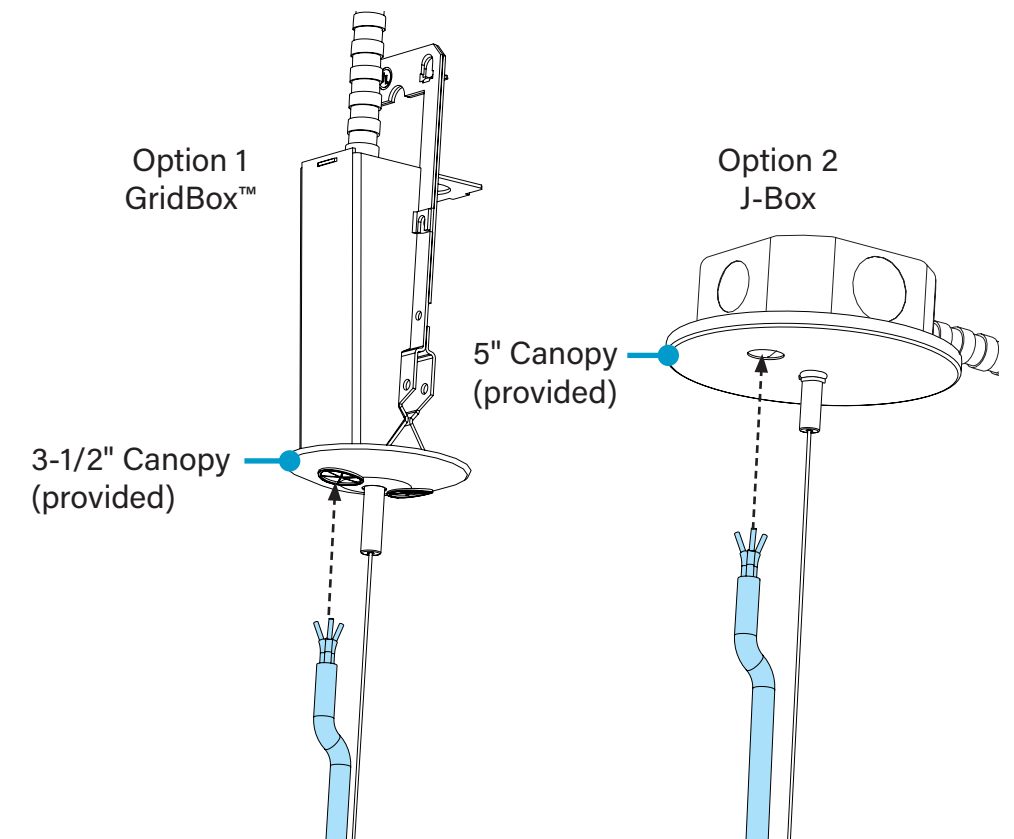

- (Option 1) Feed power cord through the 3-1/2" canopy and connect wires inside the GridBox™.
- (Option 2) Feed power cord through the 5" canopy and connect wires inside the J-Box.
- **CRITICAL: If installing an independent luminaire, perform all leveling. PROCEED TO STEP 6.**

Mounting Option 1 (shown)

3-1/2" Canopy (provided)

2" T-Bar Support Canopy (provided)

Mounting Option 2

5" Canopy (provided)

2" Drywall Support Canopy (provided)

Slip Ring w/ Set Screw (provided)

Bushing/Cable Assembly (provided)

Safety Crimp (provided)

Gripper (provided)



0-10V Dimming

# HP-3 Indirect/Direct Installation Instructions

## Step 4 - Joining Luminaires

### A. Mount Joiner/Ender to Structure

**CAUTION**  **DO NOT** attempt to join luminaires together on the floor. Damage may result when lifted. Follow these instructions.

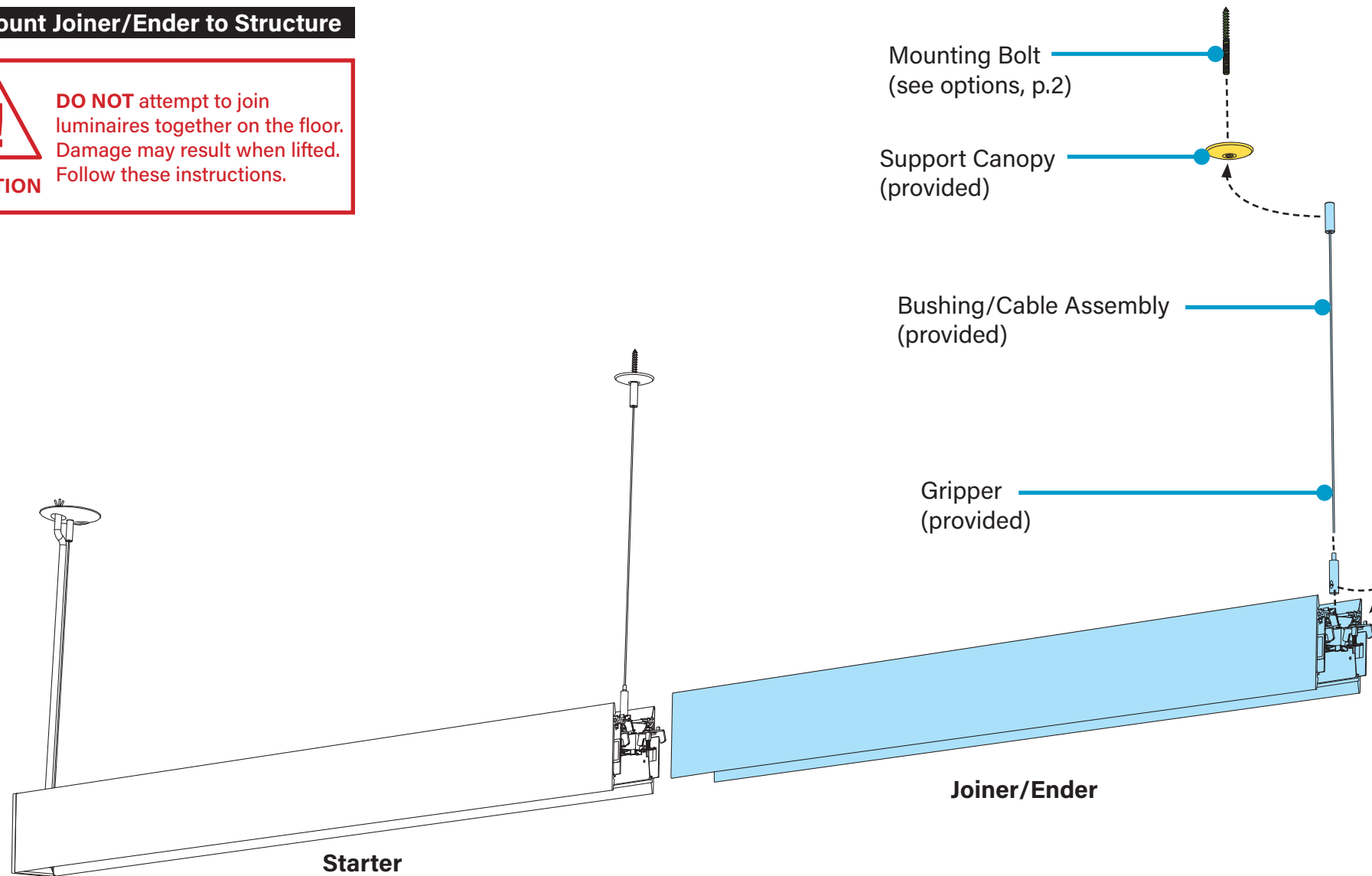

- For the joiner/ender luminaire, slide the canopy appropriate for the electrical type onto the mounting bolt (anchor bolt or caddy clip bolt)
- Thread the bushing/cable assembly onto mounting bolt.
- Attach grippers onto threaded studs found on the end plates of joiner/ender.
- While properly supporting the luminaire, maneuver the luminaire to ceiling.
- Depress the top of the gripper to feed the aircraft cable through and lead into the feed hole.

### B. Make Electrical Connections

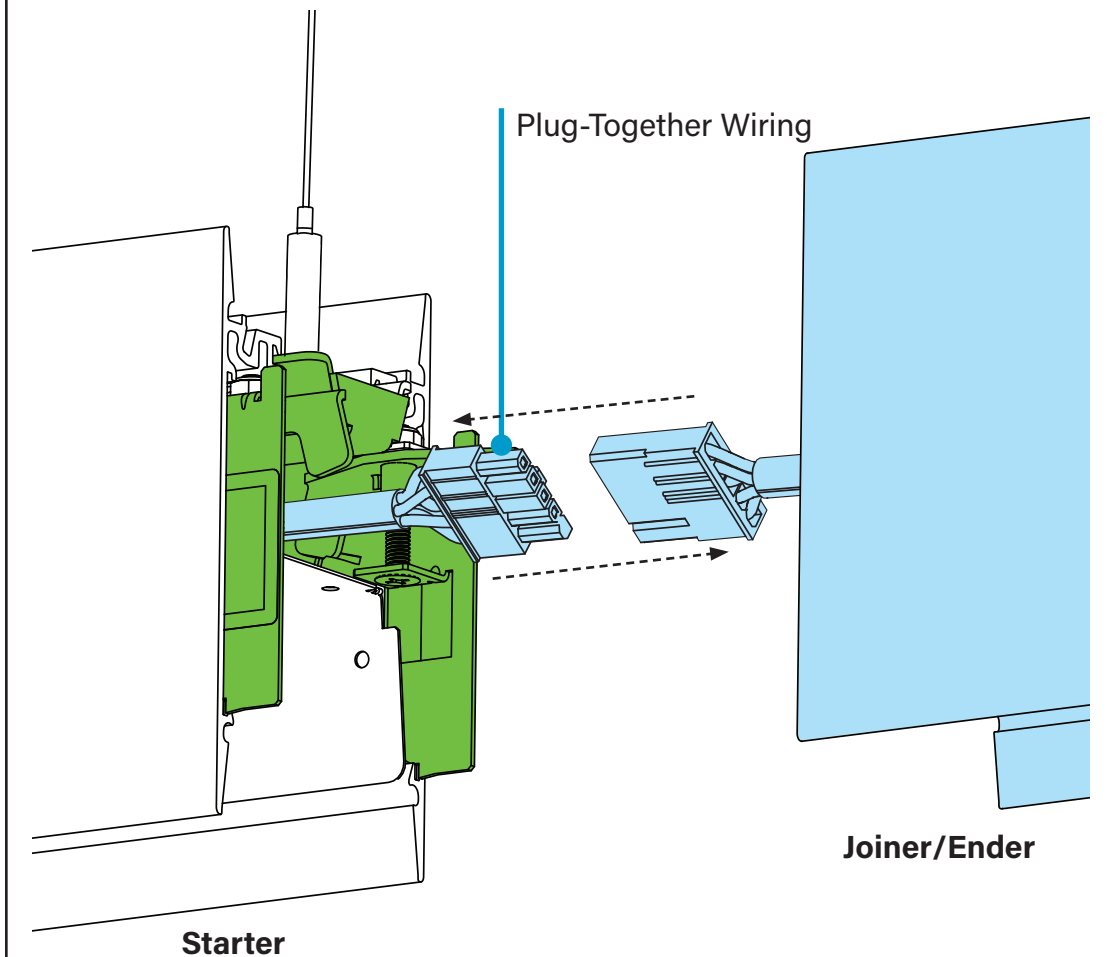



- Connect plug-together wiring.

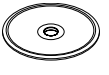

**Mounting Option 1 (shown)**

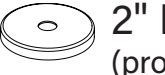
 3-1/2" Canopy (provided)  2" T-Bar Support Canopy (provided)

**Mounting Option 2**

 5" Canopy (provided)  2" Drywall Support Canopy (provided)

 Slip Ring w/ Set Screw (provided)

 Bushing/Cable Assembly (provided)  Gripper (provided)



Simple Plug-Together Wiring

# HP-3 Indirect/Direct Installation Instructions

## Step 5 - Securing Luminaire Joints

### A. Join Luminaires



**CAUTION**

Once luminaires are aligned together, **joiner luminaire is not yet secure.** Ensure it does not slide off as it rests on the starter luminaire.

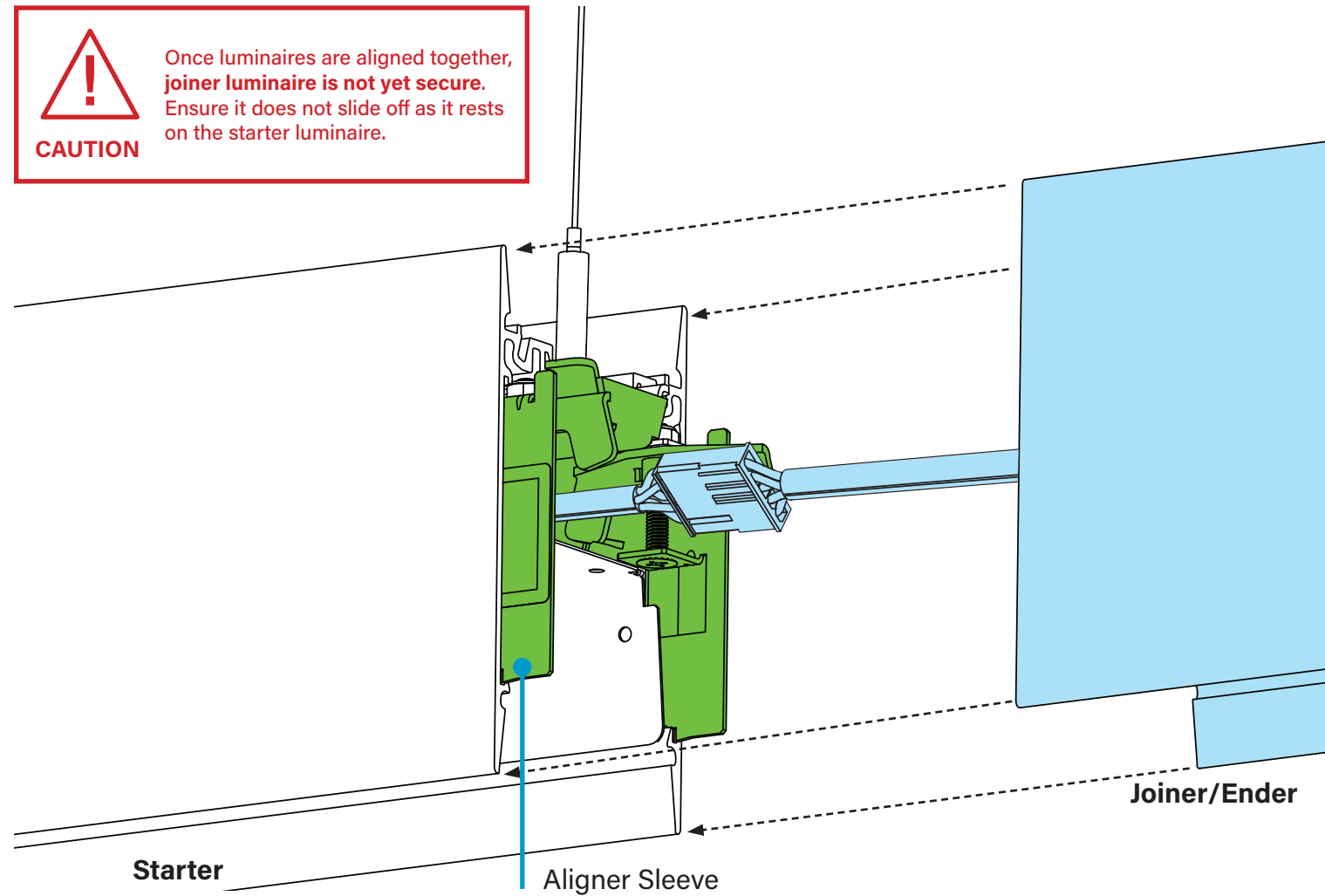

- Align joiner/ender luminaire with aligner sleeves on the starter and slide together. Be careful not to damage any wiring.
- If necessary, lift both luminaires, then slide together.

### B. Secure Easy Joint

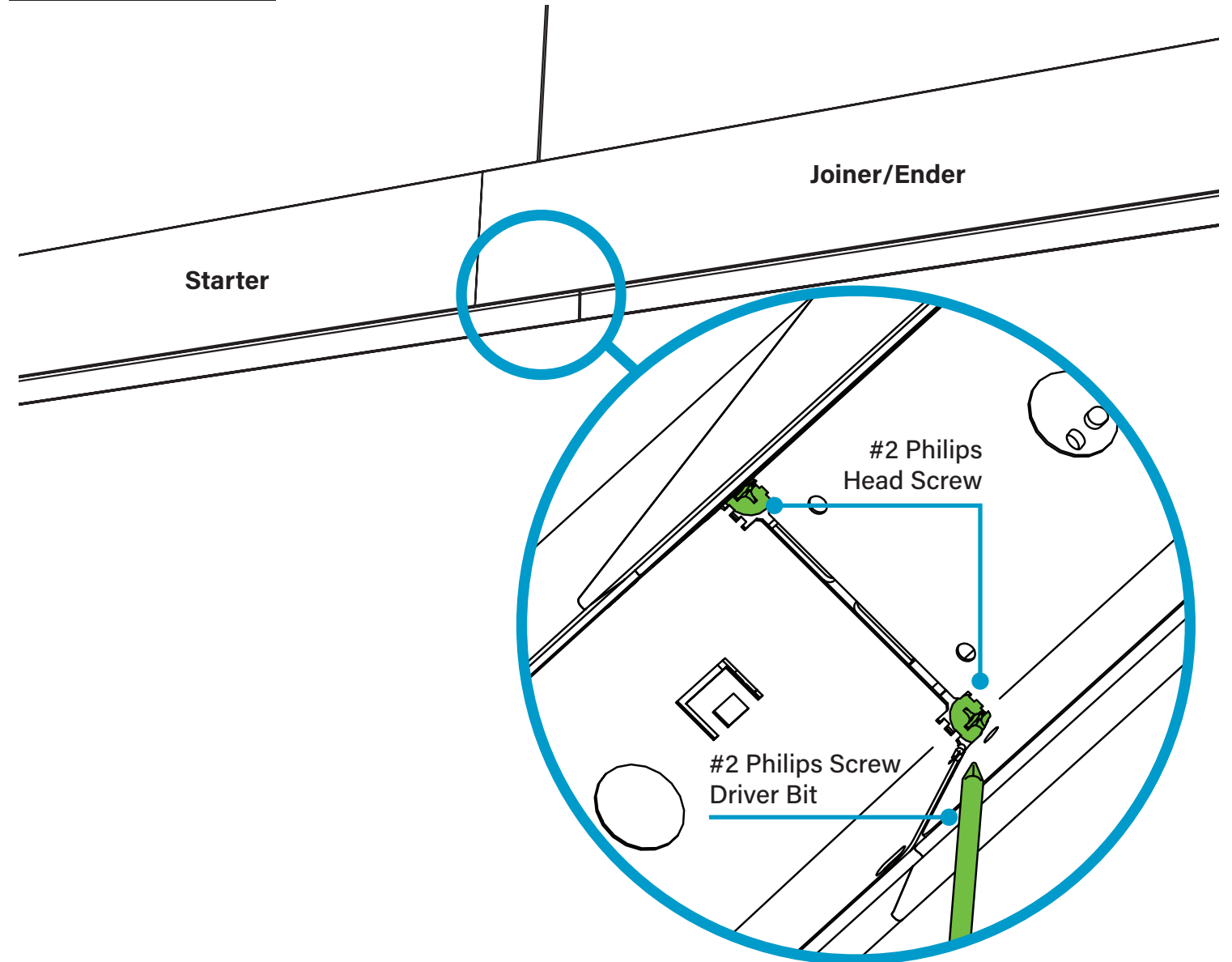

- Secure Joiner/Ender with Starter by tightening two #2 Philips Head Screws.
- Tighten two screws simultaneously and apply equal pressure to each one until tightened.
- **DO NOT USE impact drivers. Only use drivers with torque limit setting and set to low to prevent stripping the screw.**
- **DO NOT OVER TORQUE. DO NOT EXCEED 20 in-lb TORQUE**

# HP-3 Indirect/Direct Installation Instructions

## Step 6 - Closing Luminaires

### A. Final Step - Replace Diffusers

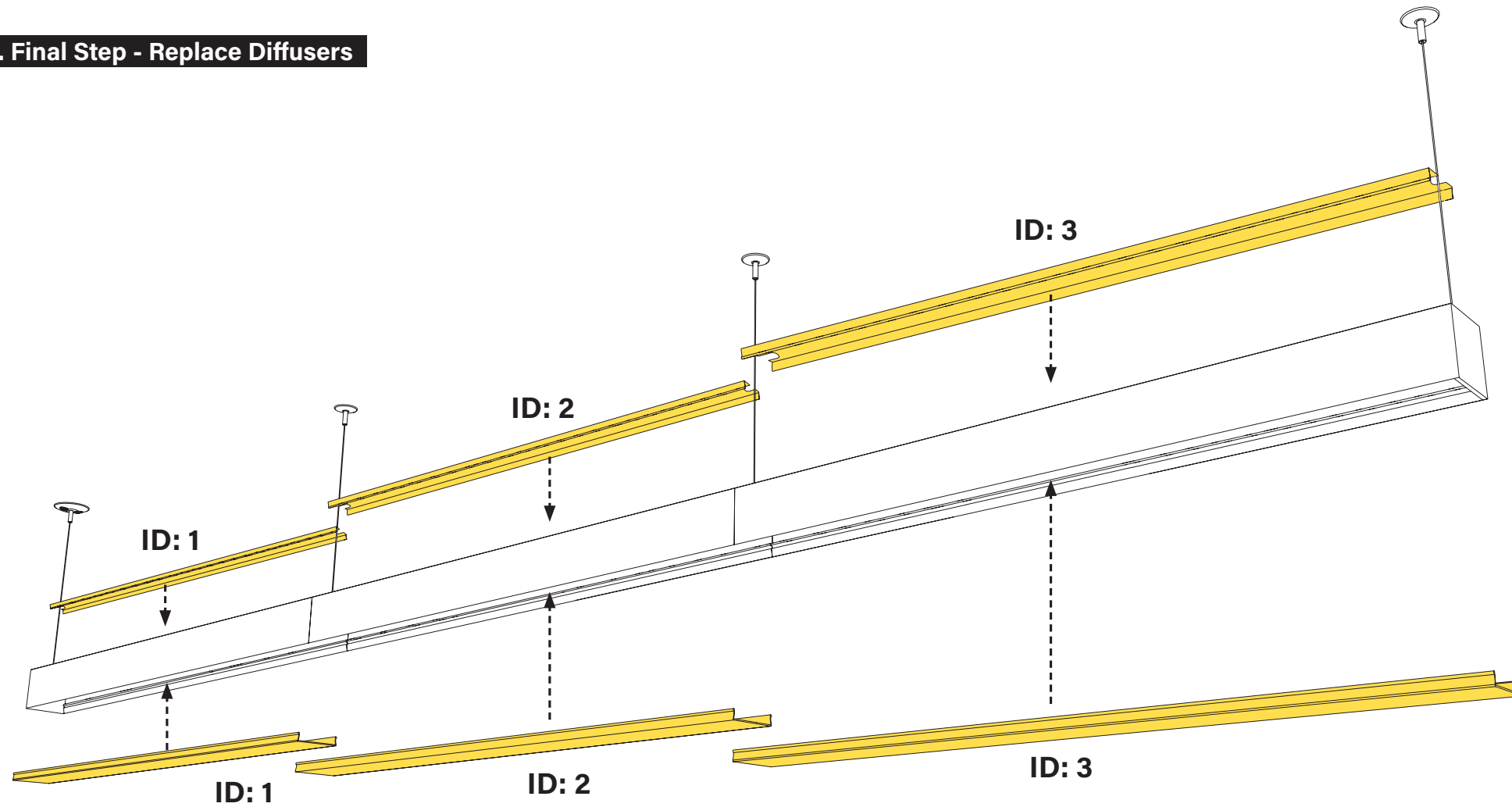

- NOTE: If your installation includes a battery backup, please see the addendum (98333) that should be included with your kitting package.
- FOR SENSOR: If luminaire contains a sensor at joint, refer to page 5 of Sensor Addendum before Closing Luminaires.
- Remove diffusers from protective plastic bags.
- **CAUTION: Wear gloves to keep the diffuser or louver surface clean.**
- **CRITICAL: Be sure to install the correct diffuser to its corresponding luminaire ID.**
- Install diffuser into luminaire body, ensuring it snaps into place.
- Turn power on to luminaires.